



IRT Electronics Pty Ltd A.B.N. 35 000 832 575
26 Hotham Parade, ARTARMON N.S.W. 2064 AUSTRALIA
National: Phone: (02) 9439 3744 Fax: (02) 9439 7439
International: +61 2 9439 3744 +61 2 9439 7439
Email: sales@irtelectronics.com
Web: www.irtelectronics.com

IRT Eurocard

Types MMM-4230 & MMX-4230

4 Channel ASI to G.703 Multiplexer / De-Multiplexer

Designed and manufactured in Australia

**IRT can be found on the Internet at:
<http://www.irtelectronics.com>**

IRT Eurocard

Types MMM-4230 & MMX-4230

4 Channel ASI to G.703 Multiplexer/De-Multiplexer

Instruction Book

Table of Contents

Section	Page
Operational Safety	2
General Description	3
Technical Specifications	4
Configuration	5
Link settings	5
Switch settings	6
45 Mb version	6
Variable Bandwidth – Channel Allocation Selection A	7
34 Mb version	8
Installation	9
SMU-4000 Installation	10
Figure 1: SMU-4000 module	10
RS-422 pin assignments	11
The RS-422 standard	12
Front and rear layouts	13
SNMP – What Is It?	14
Maintenance & Storage	16
Warranty & Service	16
Equipment return	16
Drawing List Index	17

This instruction book applies to units later than S/N 0504001.

Operational Safety:

WARNING

Operation of electronic equipment involves the use of voltages and currents that may be dangerous to human life. Note that under certain conditions dangerous potentials may exist in some circuits when power controls are in the **OFF** position. Maintenance personnel should observe all safety regulations.

Do not make any adjustments inside equipment with power **ON** unless proper precautions are observed. All internal adjustments should only be made by suitably qualified personnel. All operational adjustments are available externally without the need for removing covers or use of extender cards.

IRT Eurocard

Types MMM-4230 & MMX-4230

4 Channel ASI to G.703 Multiplexer/De-Multiplexer

General Description

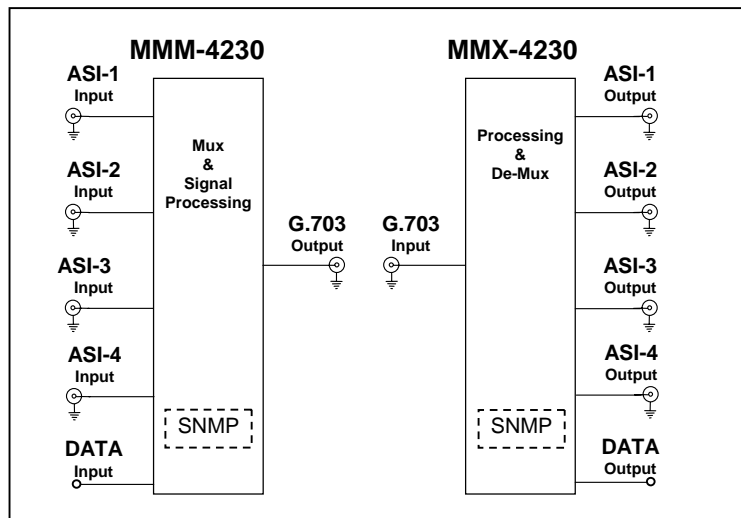

The MMM-4230 and MMX-4230 are part of a family of data transcoders for converting between the commonly used MPEG2 Transport Stream formats for video distribution in the broadcast industry.

With the MMM-4230 up to four ASI and one RS422 data signals can be multiplexed together and converted into a framed or unframed DS3 signal for transmission down a single 45 Mb/s G.703 line.

The MMX-4230 converts and demultiplexes the 45 Mb/s G.703 signal back into the original four ASI signals (at their original rates) and the RS422 data signal.

An on board switch on the MMM-4230 sets the maximum data rates for each ASI input allowing the efficient use of the available bandwidth and for protection against overuse of the bandwidth by the other channels. Total maximum data rate up to 43.5 Mb/s is allowed. Temporary packet stuffing is used to automatically bring the rate up to 45 Mb/s.

Inputs are automatically equalised for lengths of up to 300m of Belden 8281 or equivalent cable.

RS422 9600 Baud uni-directional data may also be sent on the same link.

Front panel indication and relay alarm on the MMM-4230 transmitter shows if there is an input data rate violation. Corresponding alarm on the MMX-4230 receiver shows a loss of G.703 input.

An optional Simple Network Management Protocol (SNMP) plug-in module is available for remote monitoring of input and output status, control and alarm states.

The MMM-4230 and MMX-4230 are designed to fit IRT's standard Eurocard frames as well as IRT's 4000 series frame for use with IRT's SNMP system and may be used alongside any other of IRT's analogue or digital Eurocards.

Note: Also available in a 34 Mb/s G.703 version. See "Configuration - switch settings" section for configuration table.

Standard features:

- **Up to 4 ASI and 1 Data stream on one 45 Mb/s G.703 link**
- **Input rate stuffing to 45 Mb/s G.703 rate**
- **Selectable input maximum data rates**
- **Automatic Input equalisation up to 300m**
- **Suitable for Single Frequency Network (SFN) use**
- **Optional SNMP plug-in monitoring and control module**
- **Eurocard format**

Technical Specifications

MMM-4230:

Inputs:

Type 1 4 x ASI-C 75Ω, 800 mVp-p, BNC connector.
Maximum Data Rate 40.1 Mb/s (for 188 byte packet),
43.5 Mb/s (for 204 byte packet).

Channel Data Rate Assignments (for 188 byte packet length signals)	I/P1	I/P2	I/P3	I/P4 (Mb/s)
	40	+ 0	+ 0	+ 0
	35	+ 5	+ 0	+ 0
	30	+ 10	+ 0	+ 0
	25	+ 15	+ 0	+ 0
	20	+ 20	+ 0	+ 0
	30	+ 5	+ 5	+ 0
	25	+ 10	+ 5	+ 0
	20	+ 15	+ 5	+ 0
	20	+ 10	+ 10	+ 0
	13.5	+ 13.5	+ 13.5	+ 0
		Variable		
	20	+ 10	+ 5	+ 5
	15	+ 15	+ 5	+ 5
	15	+ 10	+ 10	+ 5
	10	+ 10	+ 10	+ 10

Type 2 RS422 9600 Baud Uni directional.

Output:

Type 1 x G.703, 75Ω BNC connector.
Electrical Characteristics B3ZS encoded.
Data Rate 44.736 Mb/s.

Alarm Output: Contact closure on error, loss of power.

MMX-4230:

Input:

Type 1 x G.703, 75Ω BNC connector.
Electrical Characteristics B3ZS encoded.
Data Rate 44.736 Mb/s.

Outputs:

Type 1 4 x ASI-C 75Ω, 800 mVp-p, BNC connector.
Data Rate same as MMM-4230 input rate.
Type 2 RS-422 9600 Baud Uni directional.

Alarm Output: Contact closure on loss of G.703 input, loss of power.

Power Requirements 28 Vac CT (14-0-14) or ±16 Vdc.
Power consumption 6.5 VA.

Other

Temperature range 0 - 50° C ambient.
Mechanical Suitable for mounting in IRT 19" rack chassis with input, output and power connections on the rear panel.

Finish Front panel Grey, silk-screened black lettering & red IRT logo.
Rear assembly Detachable silk-screened PCB with direct mount connectors to Eurocard and external signals.

Dimensions 6 HP x 3 U x 220 mm IRT Eurocard.

Optional Accessories SNMP plug-in module for use with 4000 series frame fitted with SNMP "Agent".

NOTE: Also available in a 34 Mb/s G.703 version.

Due to our policy of continuing development, these specifications are subject to change without notice.

Configuration

Link settings

MMM-4230 CONFIGURATION INFORMATION

Program 4230mmm.tdf

LK6A Installed

- LK1 IN When using Switch 1 position A 'Variable Bandwidth', if the frequency of an input that has an assignment of 26.8Mb/s falls below 13.4Mb/s then the assignment will revert to 13.4Mb/s. All other conditions mentioned in the Variable Bandwidth section still apply.
OUT The frequency resetting mentioned above does not occur.
- LK2 IN Existing Reed Solomon encoding on ASI streams will pass through system.
If no RS is present on the input then RS encoding is added.
OUT Reed Solomon encoding added to input ASI streams regardless of whether existing RS encoding exists or not.
- LK3 Not used.
- LK4* IN Output G.703 signal will be "framed".
OUT Output G.703 signal will be "unframed".
- LK5* IN Output "unshaped" (recommended for output drive lengths > 68m (225ft)).
OUT Output "shaped" (recommended for output drive lengths < 68m (225ft)).
- LK7 Installing this link will terminate the RS-422 data line.
- Note: * Not applicable for 34 Mb/s (E3) version.

MMX-4230 CONFIGURATION INFORMATION

- LK1 IN Allows instantaneous changes in channel bandwidth allocation as required by the "Variable" Data Assignment.
OUT Error concealment is applied to the packet distribution.
- LK2 IN Output packet size is always 204 byte and will contain Reed Solomon code regardless of corresponding MMM-4230 input packet size.
OUT Output packet size matches that of corresponding MMM-4230 input packet size.
- LK3 IN Outputs can be individually disabled by SNMP remote control. Note that this requires SNMP functionality within IRT's SNMP frame.
OUT All outputs are always enabled. SNMP functionality not required.
- LK4* IN For input G.703 signal that is "framed".
OUT For input G.703 signal that is not "framed".
- LK5 IN Input G.703 equaliser not enabled.
OUT Input G.703 equaliser enabled.
- LK10 Installing this link will terminate the RS-422 data line.
- Note: * Not applicable for 34 Mb/s (E3) version.

Switch settings

MMM-4230 45Mb version:

The MMM-4230 Multiplexer works in a channel protection mode. The necessity for protection arises if the data rate of the inputs exceeds the maximum allowable for an MMM-4230 Transmitter (43.5Mb/s). Without protection all used channels would suffer errors. With protection, the available data rate can be divided among the input channels and if a channel tries to exceed its allocation only that channel is adversely affected.

A switch, SW1, on the MMM-4230 sets the maximum data rates for each ASI input.

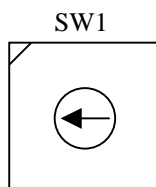

For **204 byte packets** the following allocation is possible.

Switch 1 Position	Channel Data Rate Assignment			
	I/P 1	I/P 2	I/P 3	I/P 4
0	43.5	-	-	-
1	38.26	5.46	-	-
2	32.8	10.93	-	-
3	27.33	16.4	-	-
4	21.86	21.86	-	-
5	32.8	5.46	5.46	-
6	27.33	10.93	5.46	-
7	21.86	16.4	5.46	-
8	21.86	10.93	10.93	-
9	14.6	14.6	14.6	-
A	Variable			
B	21.86	10.93	5.46	5.46
C	16.4	16.4	5.46	5.46
D	16.4	10.93	10.93	5.46
E	10.93	10.93	10.93	10.93
F	Remote			

For **188 byte packets** the following is true –

Switch 1 Position	Channel Data Rate Assignment			
	I/P 1	I/P 2	I/P 3	I/P 4
0	40.10	-	-	-
1	35.26	5.03	-	-
2	30.22	10.07	-	-
3	25.18	15.11	-	-
4	20.14	20.14	-	-
5	30.22	5.03	5.03	-
6	25.18	10.07	5.03	-
7	20.14	15.11	5.03	-
8	20.14	10.07	10.07	-
9	13.47	13.47	13.47	-
A	Variable			
B	20.14	10.07	5.03	5.03
C	15.11	15.11	5.03	5.03
D	15.11	10.07	10.07	5.03
E	10.07	10.07	10.07	10.07
F	Remote			

Note: For Channel allocation selection by SNMP control the Data Rate switch (SW1) must be set to “F”. These data rates are only the maximum allowed for the channel. Any lower rate may be used.

Variable Bandwidth – Channel Allocation Selection A:

For **188 byte packets** the following allocation is possible –

Channel Data Rate Assignment			
I/P 1	I/P 2	I/P 3	I/P 4
40.2	-	-	-
26.8	13.4	-	-
26.8	-	13.4	-
26.8	-	-	13.4
13.4	13.4	13.4	-
13.4	13.4	-	13.4
13.4	-	13.4	13.4
-	40.2	-	-
13.4	26.8	-	-
-	26.8	13.4	-
-	26.8	-	-
-	13.4	13.4	13.4
-	-	40.2	-
13.4	-	26.8	-
-	13.4	26.8	-
-	-	26.8	13.4
-	-	-	40.2
13.4	-	-	26.8
-	13.4	-	26.8

If only one channel is present then the total bandwidth is allocated to that channel.

If two channels are present and one exceeds a rate of 13.4 Mb/s then that channel will be assigned 26.8 Mb/s and the other 13.4 Mb/s. However, input 1 has priority over inputs 2, 3, & 4, input 2 has priority over inputs 3 & 4, and input 3 has priority over input 4. So even if, say, channel 2 has an input rate above 13.4 Mb/s and then input 1’s rate also increases above 13.4 Mb/s, then input 1 will be assigned the bandwidth of 26.8 Mb/s whilst input 2’s will be relegated to 13.4 Mb/s. Once a channel has been assigned a bandwidth of 26.8Mb/s it will retain the allocation until either its input signal is removed, or until a channel with higher priority requires 26.8Mb/s allocation, or there are any three channels connected.

If three channels are present they will each be assigned 13.4 Mb/s.

If four channels are present then channel 4 will not get any bandwidth.

The error concealment in the MMX-4230 will not allow an instantaneous change in channel allocation, so this should be disabled when using the above option by installing link LK1.

MMM-4230 34Mb version:

Maximum payload Data Rate 30.86 Mb/s (for 188 byte packet),
33.5 Mb/s (for 204 byte packet).

Channel Data Rate Assignments (for 188 byte packet length signals)	I/P1	I/P2	I/P3	I/P4 (Mb/s)			
	30	+	0	+	0	+	0
	27	+	3.8	+	0	+	0
	23	+	7.7	+	0	+	0
	19	+	11.5	+	0	+	0
	15.4	+	15.4	+	0	+	0
	23	+	3.8	+	3.8	+	0
	19	+	7.7	+	3.8	+	0
	15.4	+	11.5	+	3.8	+	0
	15.4	+	7.7	+	7.7	+	0
	11.5	+	11.5	+	7.7	+	0
	19	+	3.8	+	3.8	+	0
	15.4	+	7.7	+	3.8	+	3.8
	11.5	+	11.5	+	3.8	+	3.8
	11.5	+	7.7	+	7.7	+	3.8
	7.7	+	7.7	+	7.7	+	7.7

In particular, for **204 byte packets** the following allocation is possible.

Switch 1 Position	Channel Data Rate Assignment			
	I/P 1	I/P 2	I/P 3	I/P 4
0	33.5	-	-	-
1	29.31	4.18	-	-
2	25.12	8.37	-	-
3	20.93	12.56	-	-
4	16.75	16.75	-	-
5	25.12	4.18	4.18	-
6	20.93	8.37	4.18	-
7	16.75	12.56	4.18	-
8	16.75	8.37	8.37	-
9	12.56	12.56	8.37	-
A	20.93	4.18	4.18	-
B	16.75	8.37	4.18	4.18
C	12.56	12.56	4.18	4.18
D	12.56	8.37	8.37	4.18
E	8.37	8.37	8.37	8.37
F	Remote			

And for **188 byte packets** the following is true –

Switch 1 Position	Channel Data Rate Assignment			
	I/P 1	I/P 2	I/P 3	I/P 4
0	30.86	-	-	-
1	27.00	3.85	-	-
2	23.14	7.71	-	-
3	19.28	11.57	-	-
4	15.43	15.43	-	-
5	23.14	3.85	3.85	-
6	19.28	7.71	3.85	-
7	15.43	11.57	3.85	-
8	15.43	7.71	7.71	-
9	11.57	11.57	7.71	-
A	19.28	3.85	3.85	-
B	15.43	7.71	3.85	3.85
C	11.57	11.57	3.85	3.85
D	11.57	7.71	7.71	3.85
E	7.71	7.71	7.71	7.71
F	Remote			

Note: For Channel allocation selection by SNMP control the Data Rate switch (SW1) must be set to “F”. These data rates are only the maximum allowed for the channel. Any lower rate may be used.

Installation

Pre-installation:

Handling:

This equipment may contain or be connected to static sensitive devices and proper static free handling precautions should be observed.

Where individual circuit cards are stored, they should be placed in antistatic bags. Proper antistatic procedures should be followed when inserting or removing cards from these bags.

Power:

AC mains supply: Ensure that operating voltage of unit and local supply voltage match and that correct rating fuse is installed for local supply.

DC supply: Ensure that the correct polarity is observed and that DC supply voltage is maintained within the operating range specified.

Earthing:

The earth path is dependent on the type of frame selected. In every case particular care should be taken to ensure that the frame is connected to earth for safety reasons. See frame manual for details.

Signal earth: For safety reasons a connection is made between signal earth and chassis earth. No attempt should be made to break this connection.

Installation in frame or chassis:

See details in separate manual for selected frame type.

Signal Connections:

All ASI & G.703 inputs and outputs are by 75Ω BNC connectors.

Alarm output is via a two-pin 0.1" header. Alarm condition is when there is a short between these two pins. This corresponds to either a loss of power or if there is an input data rate violation on the MMM-4230, or a loss of power or a loss of G.703 input on the MMX-4230.

RS-422 data input and output connections are made via HE-14 8 pin double row connectors on both the MMM-4230 and the MMX-4230.

SNMP:

When used in an IRT FRU400 Frame with a CDM400 SNMP Module fitted, the MMM-4320 and MMX-4320 can be interrogated by an SNMP Network Management System and certain functions can also be remotely controlled. For instance, the channel bandwidth assignment can be altered and any the RS errors that have occurred can be read.

SNMP Traps on alarm states can be optionally sent.

The MIB (management information base) associated with these devices has the following OIDs (Object Identities):

- Alarms
- Channel Present
- Channel Enabled
- Channel Measured Data Rate
- Channel Rate Alarm Channel
- Channel Packet size
- Bandwidth Allocation
- Framing
- FPGA Version
- Reset
- Trap Enable
- RS Errors

SMU-4000 Installation

The SMU-4000 plug-in SNMP management controller module can only be fitted to IRT's 4000 series modules that are capable of being SNMP upgradeable. To determine whether a module is SNMP upgradeable, a square section on the main PCB is silk screened and fitted with three multipin sockets – as shown below:

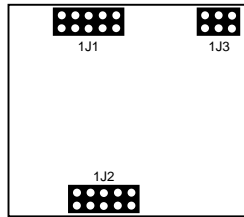

This is where the SMU-4000 plug-in SNMP management controller module is fitted. The three sets of multipins on the underside of the SMU-4000 line up with the three sets of multipin sockets on the main PCB module. Align all pins and then gently press the SMU-4000 all the way down into place.

If the SMU-4000 is not already programmed with the correct firmware to match the module that it is being plugged into, it then needs to be programmed via the pins on the topside of the SMU-4000.

Note that installation will generally be done by IRT Electronics at the time of ordering.

Note also that an SMU-4000 will only be functionally operational when the main module that it is plugged into is fitted into an IRT 4000 series frame fitted with a CDM-4000 SNMP agent and being interrogated by a suitable Network Management System.

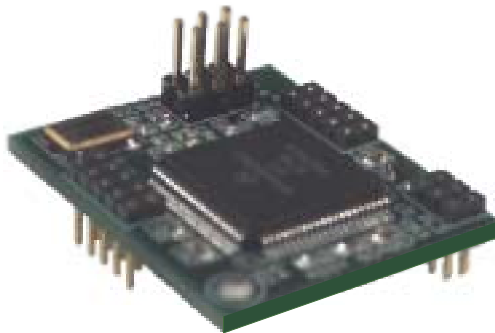
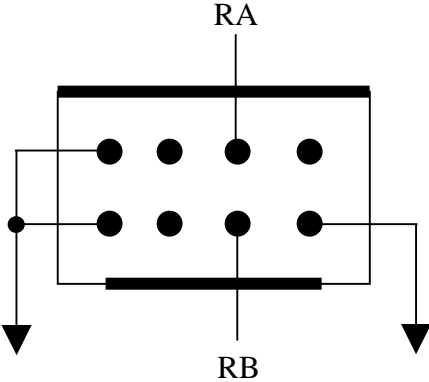

Figure 1: SMU-4000 module

RS-422 pin assignments

MMM-4230



MMX-4230

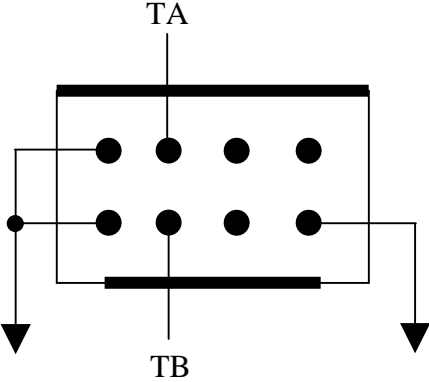

Connectors viewed from top.

The RS-422 Standard

The RS-422 standard introduced in the early 1970s defines a balanced (or differential) data communications interface using two separate wires for each signal. Due to the high noise immunity of the RS-422 standard, high data speeds and long distances can be achieved.

The RS-422 specification allows reliable serial data communications for:

- Distances up to 1200 metres
- Data rates of up to 10 Mb/s

Only one line driver is allowed on a line, and up to ten line receivers can be driven by it. Figure 1.1 illustrates RS-422.

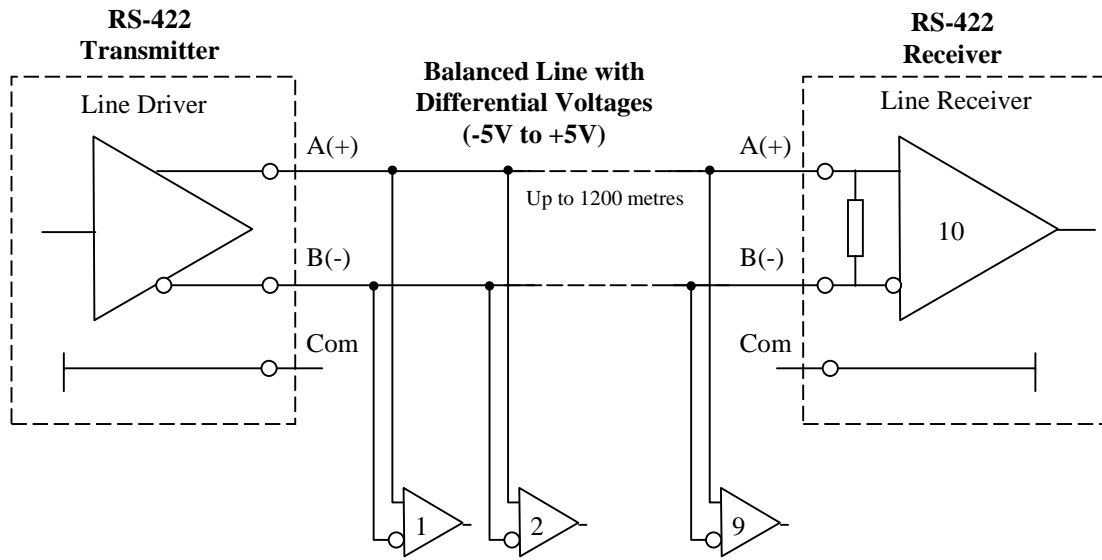

RS-422 Receivers (up to 10 devices)

Figure 1.1: RS-422 Connection

(Ref: IDC Engineers Pocket Guide)

Front & rear panel connector diagrams

The following front panel and rear assembly drawings are not to scale and are intended to show connection order and approximate layout only.

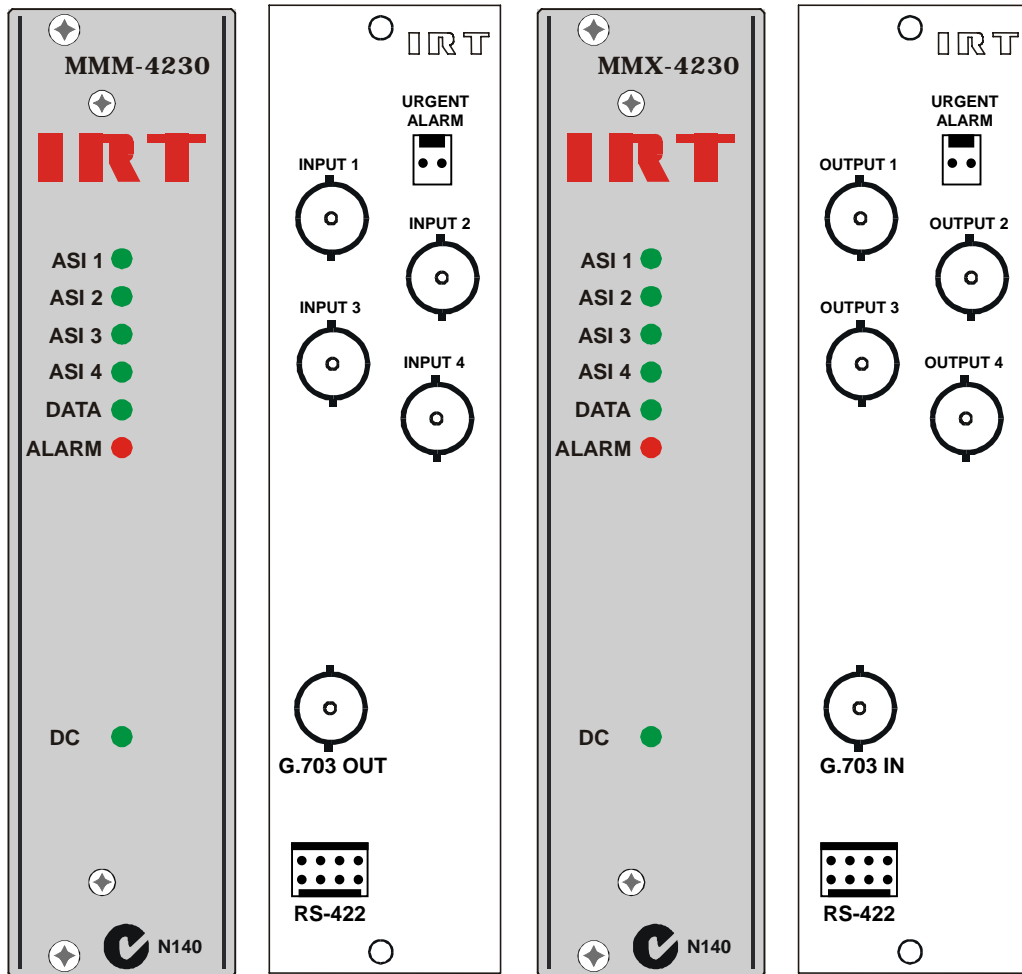

SNMP

What Is It?

SNMP stands for Simple Network Management Protocol. It is an application layer protocol for managing IP (Internet Protocol) based systems. SNMP enables system administrators to manage system performance, and to find and solve system problems. SNMP runs over UDP (User Datagram Protocol), which in turn runs over IP.

Three types of SNMP exist: SNMP version 1 (SNMPv1), SNMP version 2 (SNMPv2) and SNMP version 3 (SNMPv3). It is not the intention here to discuss the differences between various versions, only to bring attention to the fact that IRT Electronics modules, fitted with SNMP capability, use SNMPv1.

An SNMP managed network consists of three key components: Network Management Systems (*NMS*), *agents*, and *managed devices*.

An *NMS* is the console through which the network administrator performs network management functions, such as monitoring status (e.g. alarm states) and remote controlling, of a set of managed devices. One or more *NMS*s must exist on any managed network. Generally the *NMS* is a computer running third party SNMP control software. There are a number of third party SNMP software applications currently available on the market.

An *NMS* polls, or communicates with, an *agent*. An *agent* is a network management software module that resides in a *managed device*. An *agent* has local knowledge of management information and translates that information into a form compatible with SNMP. The *agent*, therefore, acts as an interface between the *NMS* and the managed devices. The *NMS* sends a request message, and control commands for the managed devices, to the *agent*, which in turn sends a response message, containing information about the *managed devices*, back to the *NMS*.

A *managed device* contains an SNMP *agent* and resides on a managed network. *Managed devices* collect and store management information and make this information available to *NMS*s using SNMP.

Managed device agent variables are organised in a tree structure known as a Management Information Base (*MIB*). Within the *MIB* are parameters pertaining to the *managed device*. An Object Identifier (OID) number within the *MIB* defines the managed device type. This is a unique number specific to the model of *managed device*. Other information relating to the device is also stored, information such as alarm states, controllable settings, etc. The *MIB* tree is organised in such a way that there will be no two *MIB* files with conflicting placements.

Normally an *NMS* polls an *agent* for information relating to the *MIB* in a managed device to be sent back to the *NMS*. When certain conditions are met within the *MIB*, such as major alarm conditions, for example, the *agent* automatically sends what is known as a *trap* to the *NMS* without any prompting from the *NMS*. This allows automatic notification of a predetermined event.

SNMP Block Diagram

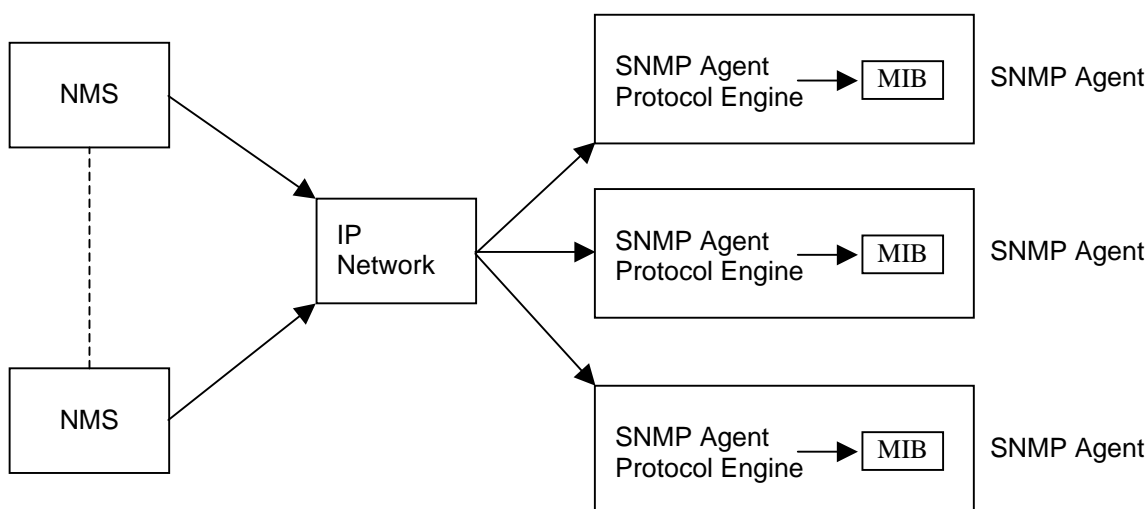

SNMP with IRT Products

IRT Electronics currently employs SNMPv1 with its 4000 series frame. The frame acts as an *agent* when fitted with a CDM-4000 module. This module has its own designated slot next to the power supply so as to not affect the number of modules that the frame will take. Communication between the *NMS*, the frame and its loaded modules are via this CDM-4000 module. Note that the *NMS* software is third party and not supplied by IRT Electronics.

Ethernet connection for SNMP operation is via an RJ45 connector on the rear of the frame, below the mains inlet. Ethernet rate runs at either 10 baseT or 100 baseT.

Frame parameters, such as Name, Address and Location, are set via an RS232 interface, a D9 connector on the rear of the frame below the mains inlet. A software terminal emulator, such as Tera Term or HyperTerminal, is used for setting and reading the parameters of the frame.

IRT modules that are SNMP compatible need a plug-in SMU-4000 module with a program relevant to the module that it is plugged into. Depending on the module, besides the module identification, parameters such as alarm states, inputs and controls etc. are communicated to the CDM-4000 *agent* via a data bus on the rear of the frame. Thus the CDM-4000 collects information on what is loaded within the frame, what positions they occupy, and their current status for communication to the *NMS* when the *NMS* sends a request for information.

In the event of a major alarm from any of the SNMP compatible modules, or power supplies, a *trap* is automatically sent by the CDM-4000 *agent* to the *NMS* without any prompting by the *NMS*. This alerts the operator to any fault conditions that may exist that need immediate attention.

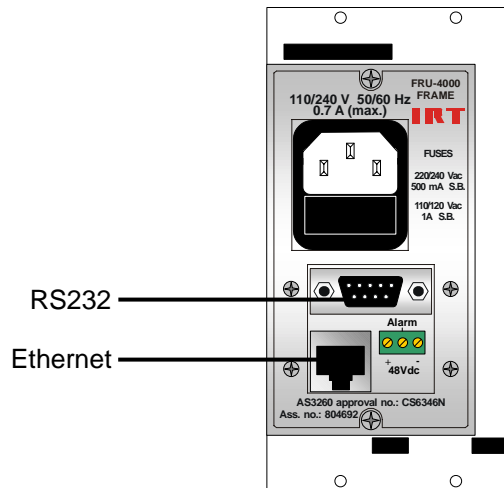

IRT SNMP Connections

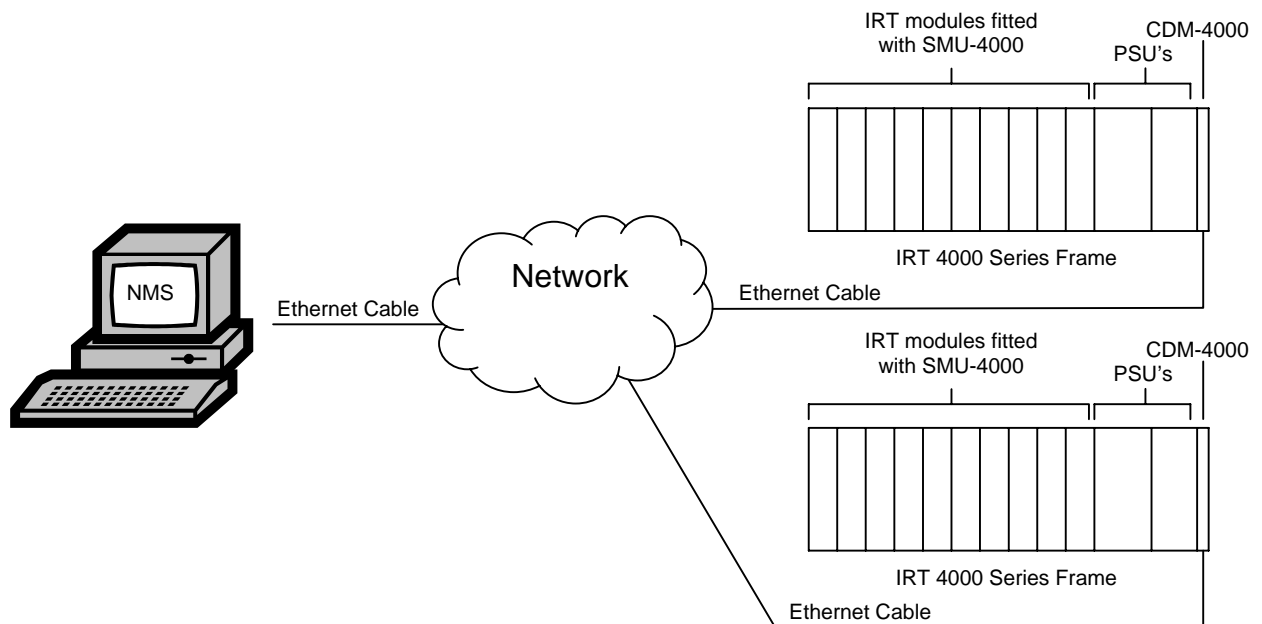

IRT 4000 Series SNMP Setup

Maintenance & storage

Maintenance:

No regular maintenance is required.

Care however should be taken to ensure that all connectors are kept clean and free from contamination of any kind. This is especially important in fibre optic equipment where cleanliness of optical connections is critical to performance.

Storage:

If the equipment is not to be used for an extended period, it is recommended the whole unit be placed in a sealed plastic bag to prevent dust contamination. In areas of high humidity a suitably sized bag of silica gel should be included to deter corrosion.

Where individual circuit cards are stored, they should be placed in antistatic bags. Proper antistatic procedures should be followed when inserting or removing cards from these bags.

Warranty & service

Equipment is covered by a limited warranty period of three years from date of first delivery unless contrary conditions apply under a particular contract of supply. For situations when “**No Fault Found**” for repairs, a minimum charge of 1 hour’s labour, at IRT’s current labour charge rate, will apply, whether the equipment is within the warranty period or not.

Equipment warranty is limited to faults attributable to defects in original design or manufacture. Warranty on components shall be extended by IRT only to the extent obtainable from the component supplier.

Equipment return:

Before arranging service, ensure that the fault is in the unit to be serviced and not in associated equipment. If possible, confirm this by substitution.

Before returning equipment contact should be made with IRT or your local agent to determine whether the equipment can be serviced in the field or should be returned for repair.

The equipment should be properly packed for return observing antistatic procedures.

The following information should accompany the unit to be returned:

1. A fault report should be included indicating the nature of the fault
2. The operating conditions under which the fault initially occurred.
3. Any additional information, which may be of assistance in fault location and remedy.
4. A contact name and telephone and fax numbers.
5. Details of payment method for items not covered by warranty.
6. Full return address.
7. For situations when “**No Fault Found**” for repairs, a minimum charge of 1 hour’s labour will apply, whether the equipment is within the warranty period or not. Contact IRT for current hourly rate.

Please note that all freight charges are the responsibility of the customer.

The equipment should be returned **to the agent who originally supplied the equipment or, where this is not possible**, to IRT direct as follows.

Equipment Service
IRT Electronics Pty Ltd
26 Hotham Parade
ARTARMON
N.S.W. 2064
AUSTRALIA

Phone: 61 2 9439 3744

Fax: 61 2 9439 7439

Email: service@irtelectronics.com

Drawing List Index

Drawing #	Sheet #	Description
804900	1	MMM-4230 4 Channel ASI to G.703 Multiplexer Schematic – sheet 1
804900	2	MMM-4230 4 Channel ASI to G.703 Multiplexer Schematic – sheet 2
804900	3	MMM-4230 4 Channel ASI to G.703 Multiplexer Schematic – sheet 3
804902	1	MMX-4230 G.703 to 4 Channel ASI De-Multiplexer schematic – sheet 1
804902	2	MMX-4230 G.703 to 4 Channel ASI De-Multiplexer schematic – sheet 2
804902	3	MMX-4230 G.703 to 4 Channel ASI De-Multiplexer schematic – sheet 3

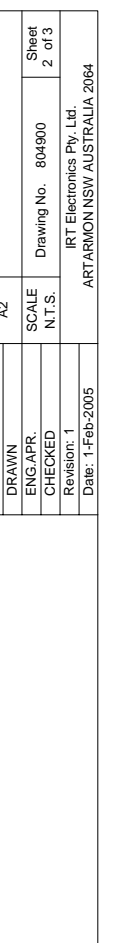
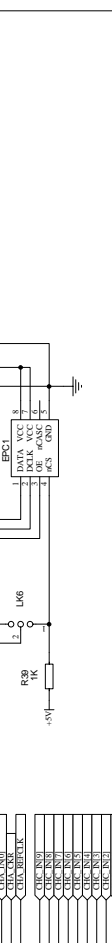
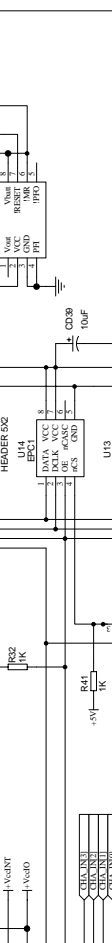
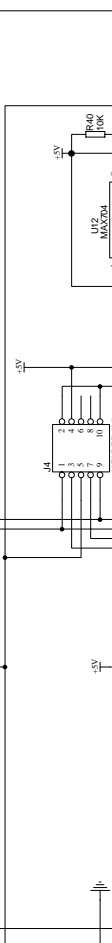
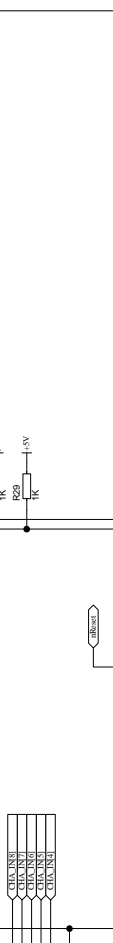
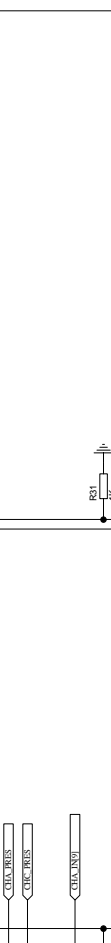
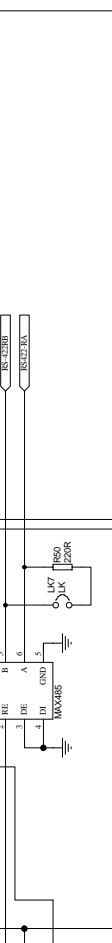
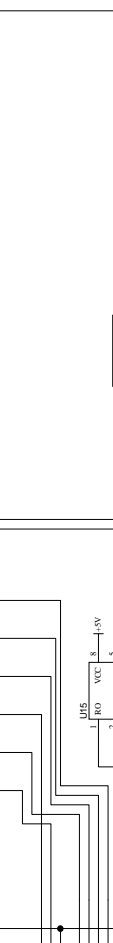
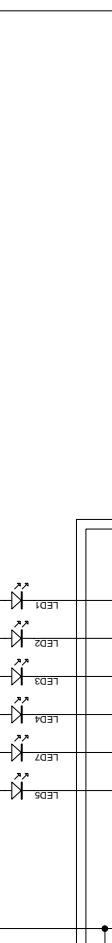
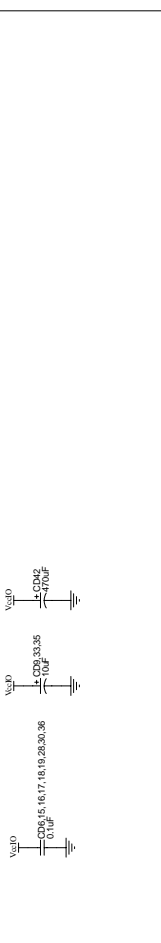
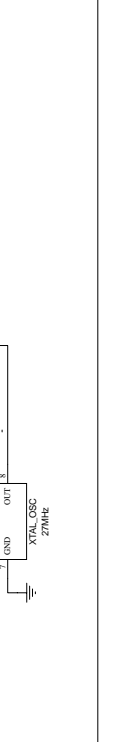
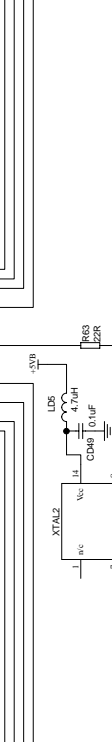
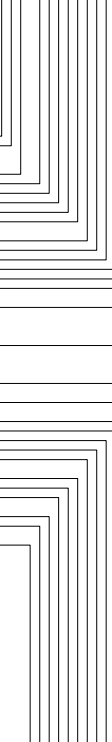
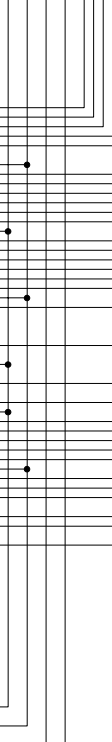
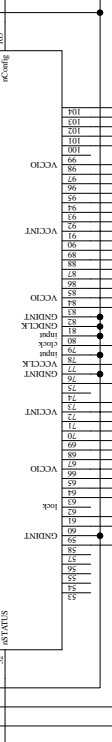
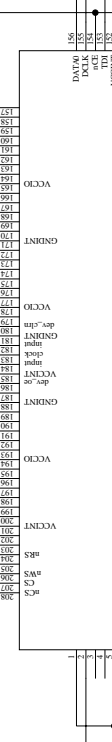
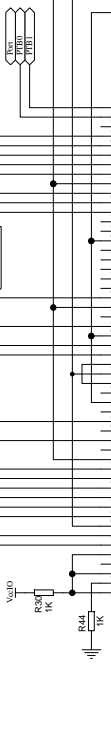
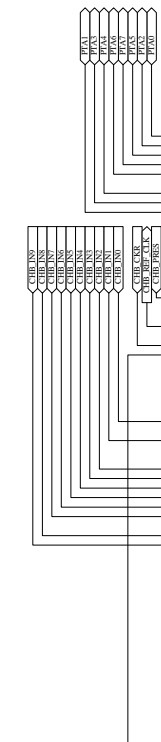
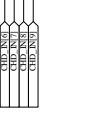
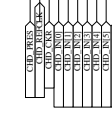
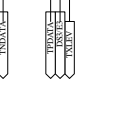
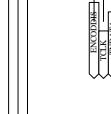
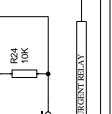
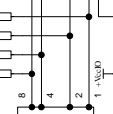
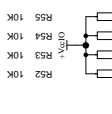
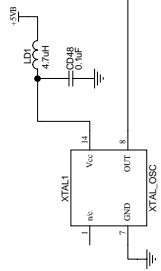
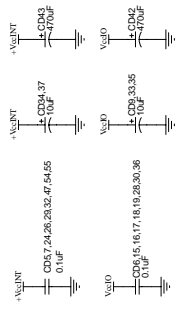

COPYRIGHT DO NOT COPY NOR DISCLOSE TO ANY THIRD PARTY WITHOUT WRITTEN CONSENT		SIZE A2	Title MMM-4230
DRAWN ENG. APR. CHECKED	SCALE N.T.S.	Drawing No. 804900 Revision: 1	
Date: 1-Feb-2005		ARTARMON NSW AUSTRALIA 2064	

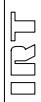

Sheet
2 of 3

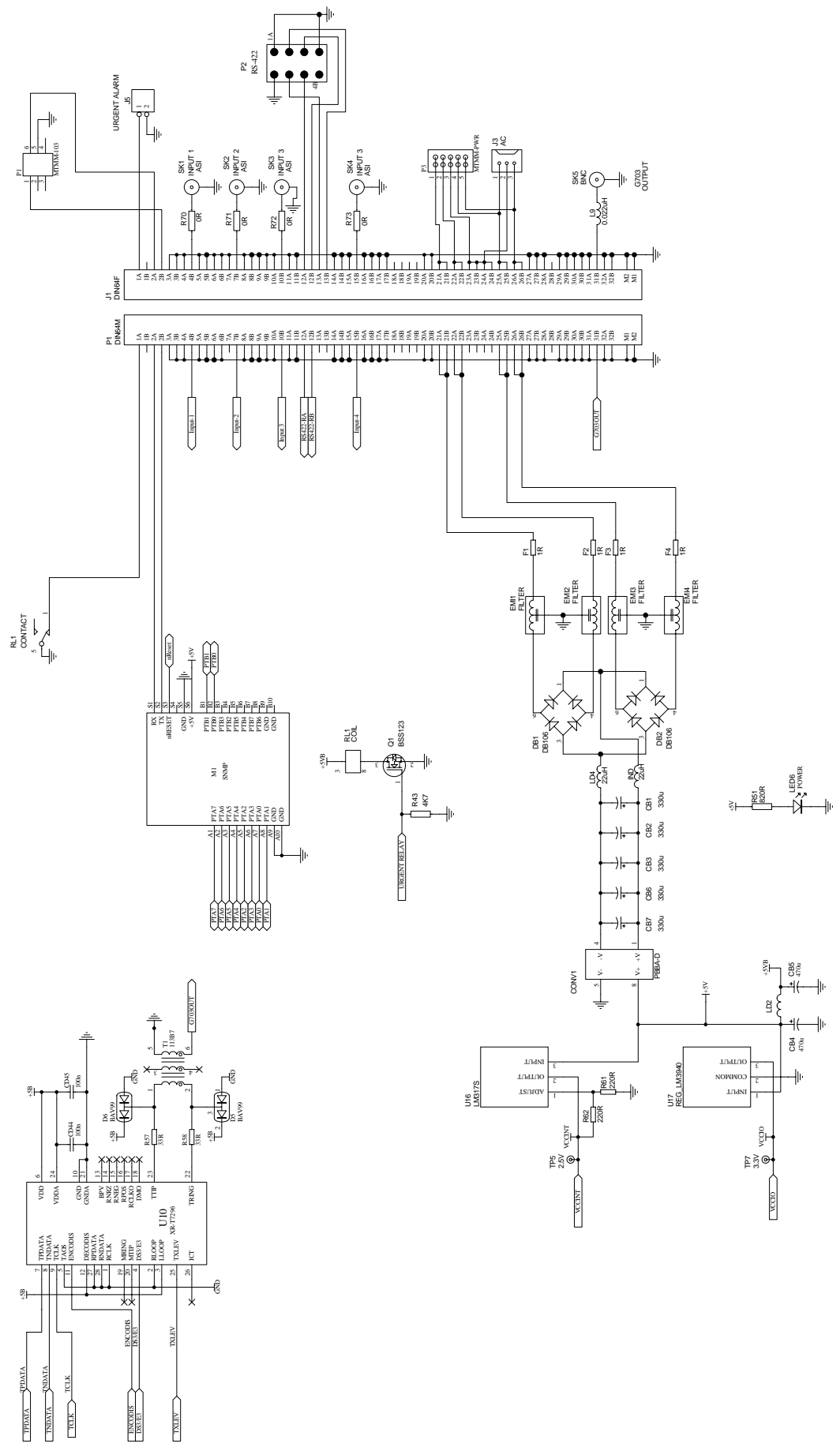

IRT	
Copyright DO NOT COPY NOR DISCLOSE TO ANY THIRD PARTY WITHOUT WRITTEN CONSENT	Title MMM-4230
DRAWN ENG. APR. CHECKED	SIZE A2
Revision: 1	SCALE N.T.S.
Date: 1-Feb-2005	Drawing No. 804900
	Sheet 3 of 3
	IRT Electronics Pty. Ltd. ARTARMON NSW AUSTRALIA 2064

8049025_2.dwg
 8049025_2.dwg
 8049025_2.dwg

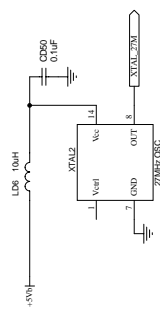
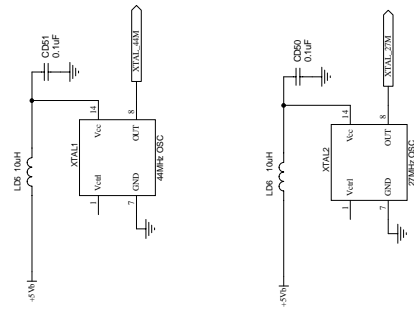
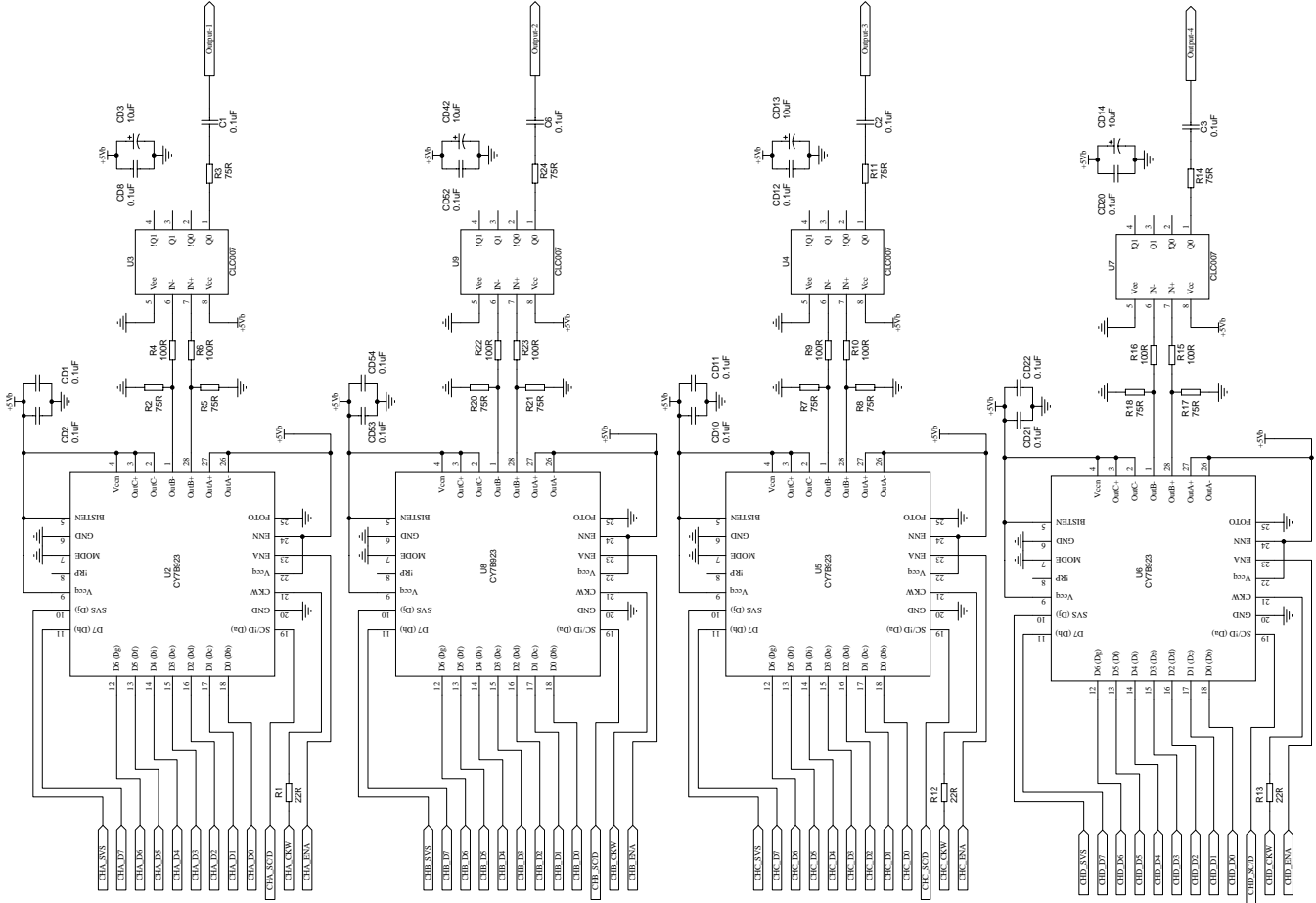

COPYRIGHT DO NOT COPY NOR DISCLOSE TO ANY THIRD PARTY WITHOUT WRITTEN CONSENT		Title MMX-4230	
DRAWN	SCALE N.T.S.	SIZE A2	Drawing No. 804902
ENG. APPR. CHECKED	Revision: 1	IRT Electronics Pty. Ltd. ARTARMON NSW AUSTRALIA 2064	
Sheet 1 of 3			

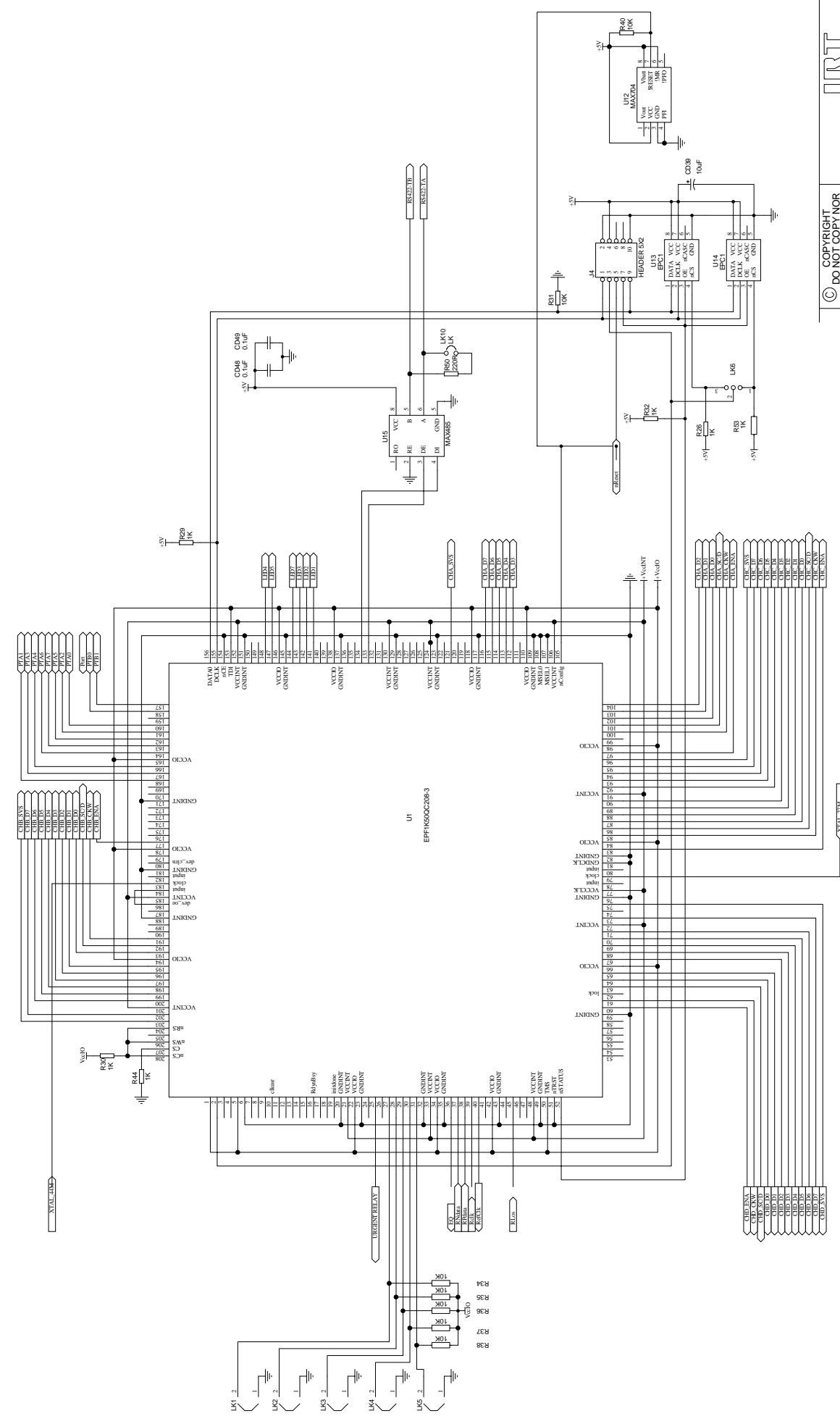
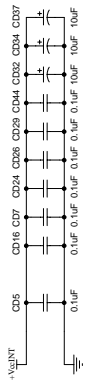
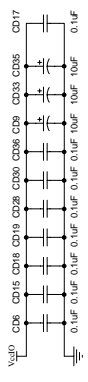

IRT

COPYRIGHT DO NOT COPY NOR DISCLOSE TO ANY THIRD PARTY WITHOUT WRITTEN CONSENT		Title	MMX-4230
SIZE	A2	SCALE	N.T.S.
DRAWN	ENG.APR.	CHECKED	Revision: 1
Date: 1-Feb-2005		IRT Electronics Pty Ltd ARTARMON NSW AUSTRALIA 2064	

